

SERVICE ENTRANCE/ANCHOR BOLT LAYOUT		
ITEM	DESCRIPTION	QTY.
a	3" X 6" SLOT IN FLOOR WITH 5" X 8" REMOVABLE SCREW-DOWN ALUMINUM TREADPLATE LID, (2) SCREWS REQ'D. ONE AT EACH END, FOR ELECTRICAL SERVICE ENTRANCE TO C.B. PANEL.	1
b	2" X 2" X 1/4" (MIN) STEEL ANCHOR CLIP WITH A 3/4" ANCHOR BOLT HOLE, ONE EACH CORNER. ANCHOR BUILDING AFTER FINAL LOCATION. ANCHOR BOLTS NOT INCLUDED.	4
c	OUTER EDGE OF BUILDING	1
d	BASE PERIMETER FRAME	1
e	INTERIOR WALL FACE	1
f	SUGGESTED MINIMUM FOUNDATION	1

GENERAL SITE INSTALLED ITEMS PROVIDED BY OTHERS	
1	PROVIDE 120V/240V, SINGLE PHASE, 3-WIRE SERVICE WITH GROUND. <b>(CAN BE WIRED AS SINGLE PHASE 120/208V)</b>
2	CONCRETE FOUNDATION MINIMUM 6" DEEP, 3,000 PSI MINIMUM (28 DAY ACI 318). THE FOUNDATION SHOULD BE A MINIMUM OF 24" WIDER THAN THE BUILDING FOOT PRINT DIMENSIONS. THIS IS TO PROVIDE A 12" CONCRETE BORDER ON EACH SIDE OF THE BUILDING.
3	ADEQUATE SIZE DRILLED ANCHOR BOLTS. SUGGESTED SIZE: 5/8" X 4 1/2" POWER FASTENERS "POWER STUD" CATALOG #7332.

LINE ITEMS		
ITEM #	DESCRIPTION	QTY
1	COUNTER - 18" DEEP PAINTED GALVANIZED STEEL MOUNTED 32" A.F.F.	1
2	PAINTED STORAGE DRAWER.	1
3	DOOR - 36" SLIDING STEEL WITH WEATHER-STRIPPING, BALL BEARING HANGERS, HEAVY DUTY TRACK, SAFETY GLAZING, HOOK BOLT LOCK, AND HARDWARE.	1
4	2" DIAMETER HOLE IN COUNTER FOR DROP CORDS.	1
5	DUPLEX OUTLET MOUNTED ABOVE COUNTER.	1
6	INTERIOR LIGHT WITH WALL SWITCH - 48" LED LIGHT FIXTURE WITH ACRYLIC LENS.	1
7	WALL SWITCH FOR INTERIOR LIGHT.	1
8	HEATER - 120V/1,500 WATT WALL MOUNTED WITH INTEGRAL THERMOSTAT CONTROL.	1
9	AIR CONDITIONER - 240V/11,600 THROUGH WALL MOUNTED WITH INTEGRAL THERMOSTAT CONTROL.	1
10	SINGLE RECEPTACLE FOR AIR CONDITIONER.	1
11	CIRCUIT BREAKER PANEL - 12 SPACE, 120/240V, 1Ø-3 WIRE WITH GROUND BAR, 100 AMP MAIN BREAKER, AND ALL BRANCH BREAKERS FOR FACTORY INSTALLED DEVICES PROVIDED.	1

GENERAL CONSTRUCTION NOTES	
PAR-KUT BOOTHS ARE OF SINGLE UNIT WELDED STEEL CONSTRUCTION, FACTORY ASSEMBLED AND DELIVERED SET UP. FAILURE TO SECURELY ANCHOR BOOTH MAY RESULT IN OVERTURNING OF UNIT AND SERIOUS INJURY TO OCCUPANT.	
<b>GLAZING SPECIFICATIONS</b> - SAFETY GLAZING SET IN PAINTED GALVANIZED STEEL EXTERIOR WINDOW FRAMES WITH INTERIOR ALUMINUM GLAZING STOPS.	
<b>PAINT</b> - FINISH SHALL BE SINGLE COLOR OF CHOICE UNLESS OTHERWISE SPECIFIED, AXALTA IMRON POLYURETHANE INDUSTRIAL COATING. SHALL BE APPLIED TO ALL EXPOSED METAL SURFACES. THIS EXCLUDES ROOF SURFACE, ALUMINUM WINDOW FRAMES AND ANY STAINLESS STEEL COMPONENTS (IF USED).	
<b>ELECTRICAL</b> - ALL WIRING BY PAR-KUT TO BE #12(MIN) STRANDED COPPER, THHN ENCLOSED IN 1/2"(MIN) E.M.T. AND FLEXIBLE METAL CONDUIT WHERE APPLICABLE PER NATIONAL ELECTRIC CODE. ALL ELECTRICAL EQUIPMENT WILL BE LISTED BY U.L. OR EQUIVALENT RECOGNIZED NATIONAL TESTING LABORATORY. ALL WIRING TO TERMINATE AT C.B. PANEL. ALL CIRCUITS HAVE GREEN GROUND WIRE.	
BOOTH WILL HAVE A 6" CANOPY OVERHANG ON ALL SIDES.	
REMOVABLE LIFTING RING(S) ARE PROVIDED ON ROOF.	
LIFTING RING(S) ARE DESIGNED FOR A STRAIGHT VERTICAL LIFT ONLY. SPREADER BARS MUST BE USED WHERE APPLICABLE TO ENSURE STRAIGHT VERTICAL LIFT. ALL WARRANTIES WILL BE <b>VOID</b> IF NOT LIFTED IN THIS MANNER.	
<b>NO ON SITE WORK BY PAR-KUT.</b>	
ACTUAL LOCATION OF ELECTRICAL DEVICES MAY VARY DUE TO INSTALLATION CONSTRAINTS, SHIPPING RESTRICTIONS, OR FOR PROPER PLACEMENT TO SATISFY APPLICABLE CODES.	

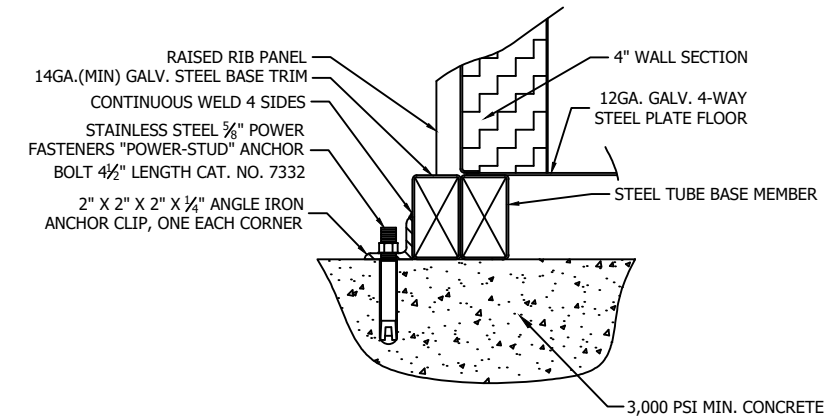
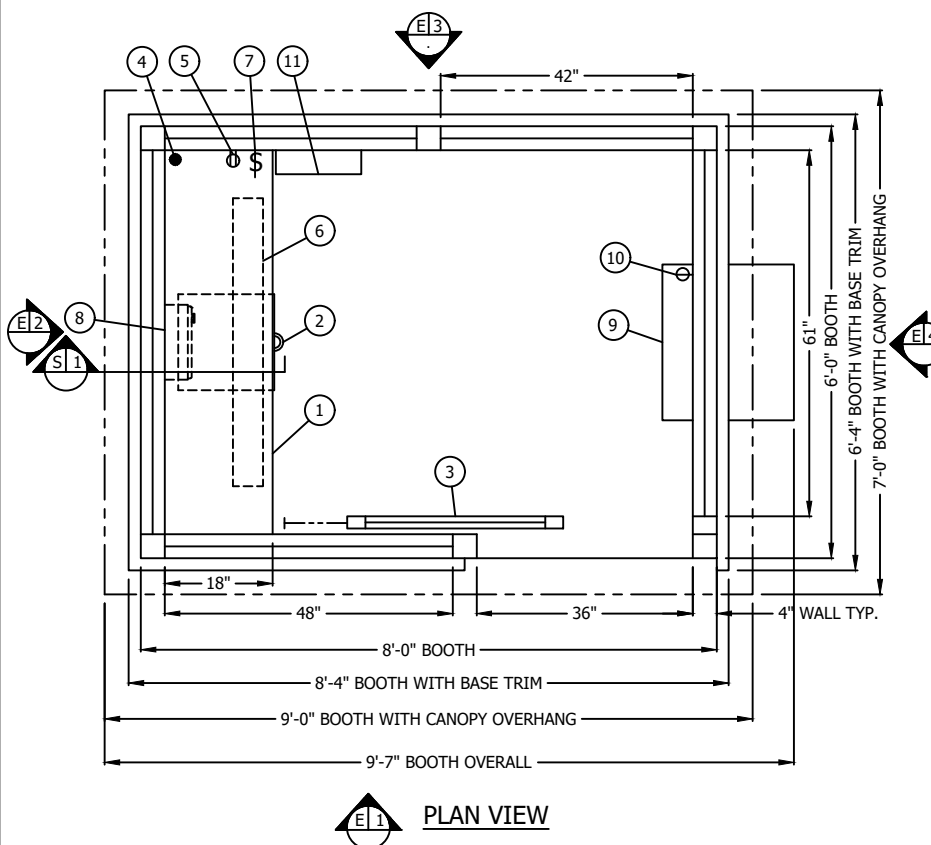

FIELD DRILLED ANCHOR BOLT DETAIL  
NO SCALE

THIS DRAWING IS FOR REFERENCE PURPOSES ONLY. PAR-KUT BUILDINGS MUST BE SECURELY ANCHORED IN PLACE AND MUST BE PROPERLY GROUNDED. ADEQUATE SIZED ANCHOR BOLTS SHALL BE USED. THE SIZE AND DEPTH OF THE ANCHORS SHOULD BE OF SUFFICIENT DESIGN TO WITHSTAND THE HIGHEST RECORDED WIND SPEEDS/SEISMIC DESIGN CATEGORY IN THE AREA OF INSTALLATION. CONSULT A PROFESSIONAL ENGINEER FAMILIAR WITH THE WEATHER CONDITIONS IN THE AREA.

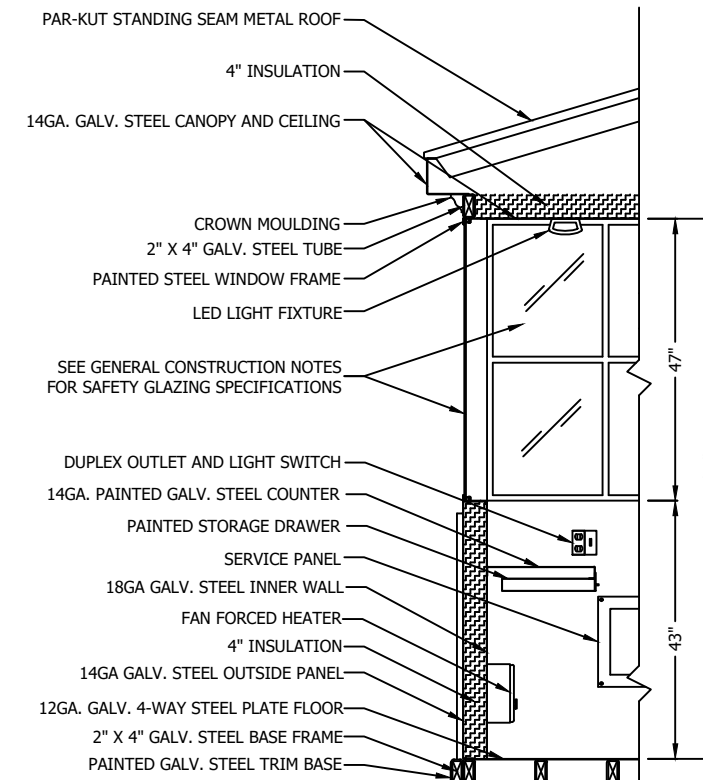

SECTION  
NO SCALE

NOTE: THIS PRINT AND DESIGN ARE THE PROPERTY OF PAR-KUT INTERNATIONAL, INC. IT MUST NOT BE REPRODUCED IN ANY MANNER, NOR SHALL IT BE SUBMITTED TO OUTSIDE PARTIES FOR EXAMINATION WITHOUT OUR CONSENT. IT SHALL BE USED ONLY AS A MEANS OF REFERENCE TO WORK DESIGNED AND FURNISHED BY PAR-KUT. PAR-KUT RESERVES THE RIGHT TO MAKE CHANGES TO DESIGN FOR ENGINEERING PURPOSES WITHOUT NOTICE. REVISIONS MAY NOT BE NOTED.

PAR-KUT INTERNATIONAL, INC.  
40961 Production Drive  
Harrison Twp., Mich.  
48045-1351  
PH. (586) 468-2947  
www.parkut.com

GENERAL NOTES & COLORS		
<b>HIGH GLOSS PAINT COLOR:</b> _____		
<b>PAR-KUT STANDING SEAM METAL ROOF COLOR:</b> _____		
<b>GLAZING TINT COLOR:</b> _____ (PLEASE SPECIFY COLORS)		
SHIPPING NOTES		
<b>OVERALL SHIPPING DIMENSIONS:</b>	7'-0"W X 9'-7"L X 9'-10"H ±	
<b>ESTIMATED WEIGHT:</b>	3,800 LBS. ±	
SOME ITEMS MAY BE SHIPPED LOOSE TO MEET SHIPPING CONSTRAINTS. <b>DRAIN DOWNSPOUTS ARE SHIPPED LOOSE AND INSTALLED ON SITE BY OTHERS.</b>		

STANDARD 6' X 8' PRESIDENTIAL SERIES MODEL 86PRES		
DWG# PK86pres	SHEET	A-1
PO#	SCALE	3/8"=12"
DATE	DRAWN BY	DPH
1-4-2017	SIZE	6' X 8'
CHK'D BY:	REVISED	03-03-2021
	QTY	
	SALES REPRESENTATIVE	

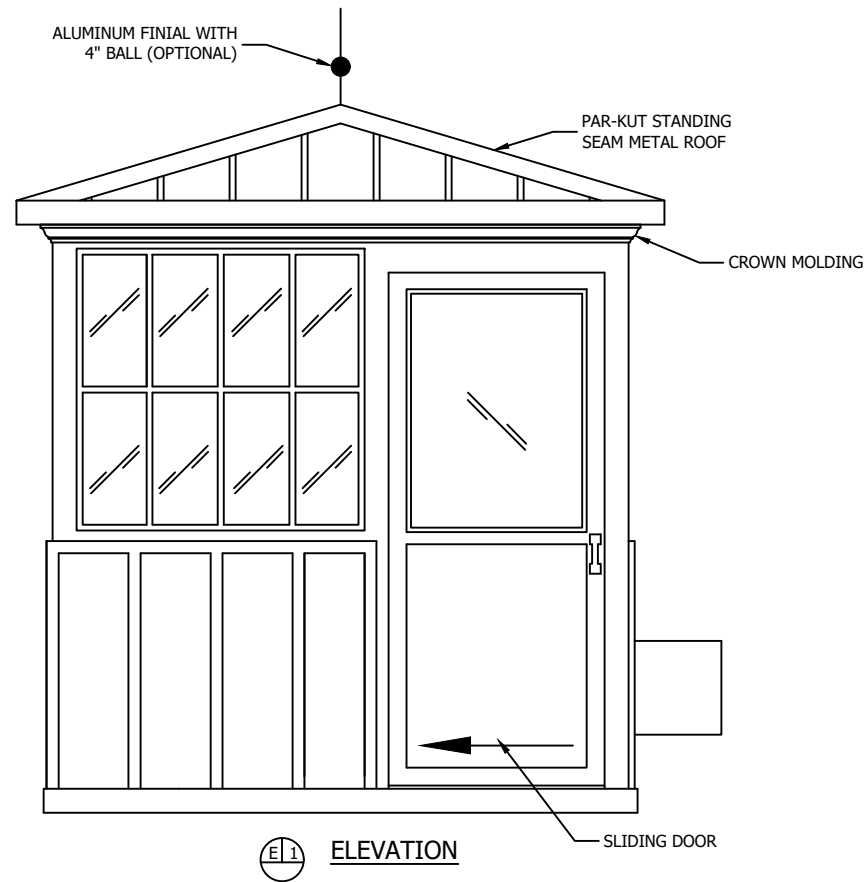

E1 ELEVATION

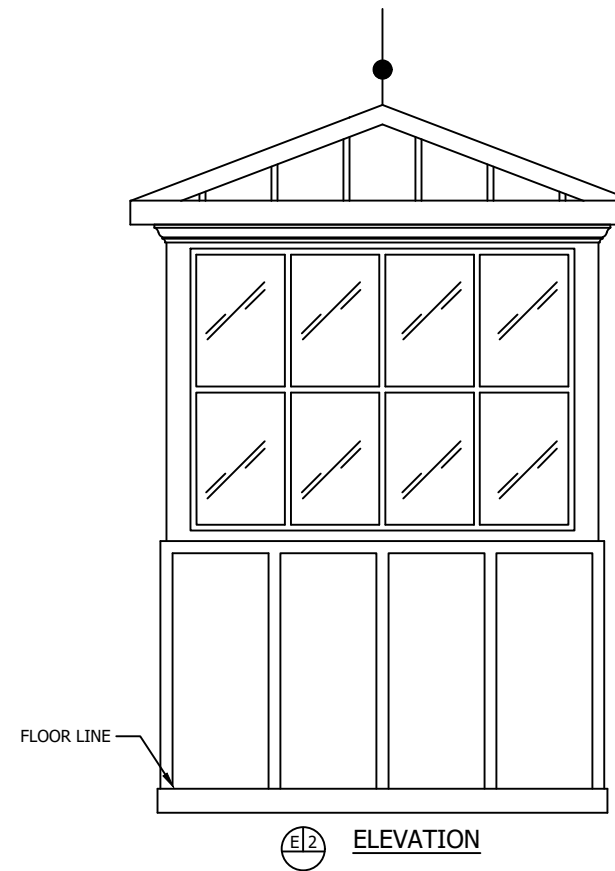

E2 ELEVATION

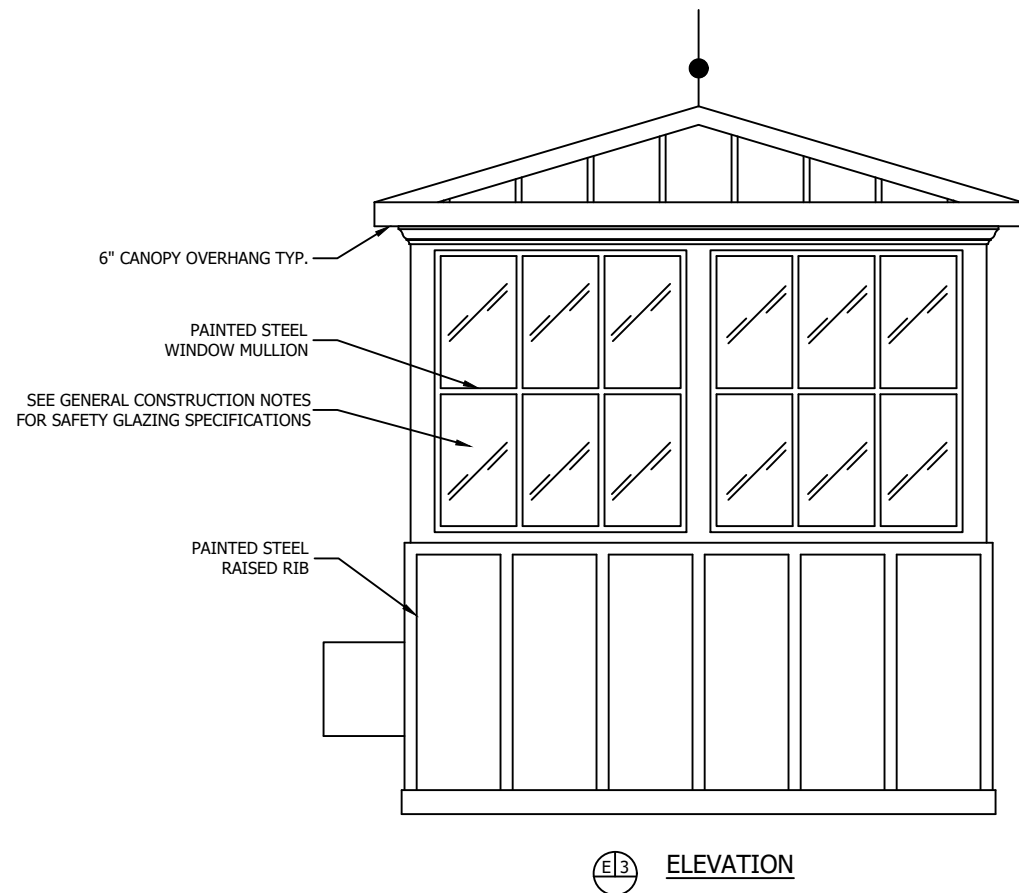

E3 ELEVATION

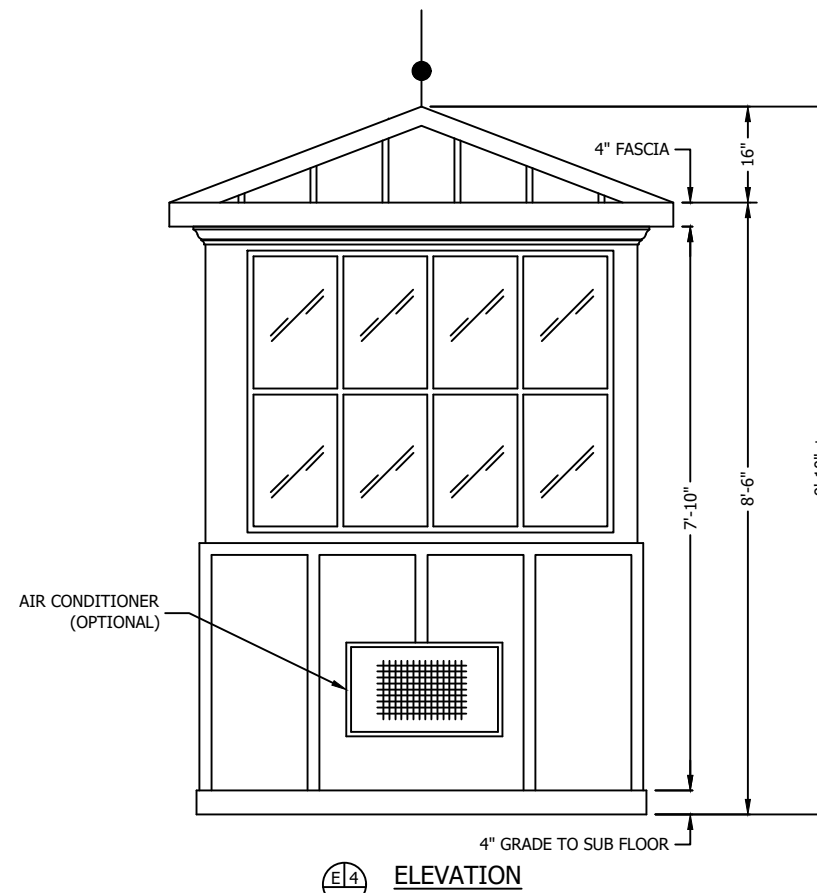

E4 ELEVATION

NOTE: THIS PRINT AND DESIGN ARE THE PROPERTY OF PAR-KUT INTERNATIONAL, INC. IT MUST NOT BE REPRODUCED IN ANY MANNER, NOR SHALL IT BE SUBMITTED TO OUTSIDE PARTIES FOR EXAMINATION WITHOUT OUR CONSENT. IT SHALL BE USED ONLY AS A MEANS OF REFERENCE TO WORK DESIGNED AND FURNISHED BY PAR-KUT. PAR-KUT RESERVES THE RIGHT TO MAKE CHANGES TO DESIGN FOR ENGINEERING PURPOSES WITHOUT NOTICE. REVISIONS MAY NOT BE NOTED.

PAR-KUT INTERNATIONAL, INC.  
 40961 Production Drive  
 Harrison Twp., Mich.  
 48045-1351  
 PH. (586) 468-2947  
 www.parkut.com

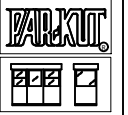

DWG# PK86pres SHEET A-2

STANDARD 6' X 8'  
 PRESIDENTIAL SERIES  
 MODEL 86PRES

PO#	SCALE	DRAWN BY	REVISED
	3/8"=12"	DPH	03-03-2021
DATE	SIZE	QTY	
1-4-2017	6' X 8'		
CHK'D BY:	SALES REPRESENTATIVE		